

Miniature Toggle

## Specifications

Electrical Ratings	5A @ 120VAC, 28VDC 2A @ 250VAC See Contact Options	Dielectric Strength	1500Vrms min
Electrical Life	40,000 cycles typical	Insulation Resistance	>1000MΩ min
Contact Resistance	≤10mΩ initial @ 2-4VDC, 100mA	Operating Temperature	-40°C to 85°C
		Storage Temperature	-40°C to 85°C

## Materials

Actuator	Brass, Chrome Plated
Housing	Diallyl Phthalate (DAP)
Cover	Stainless Steel
Bushing	Brass, Nickel Plated
Bracket	Brass, Tin Plated
Contacts	Copper Alloy, Silver or Gold Plated
Terminals	Copper Alloy, Silver or Gold Plated

## Features

- Wide variety of applications from consumer electronics to commercial
- Standard epoxy sealed terminations
- Gold contacts available for low power applications
- Available support brackets for greater stability
- Up to four poles with seven functions available
- Anti-rotation feature on flat toggles
- High torque bushing preventing separation from frame during installation
- Wide variety of terminal options

Miniature Toggle

**Ordering Information**

1. Series	ANT	2	3	T	E	B	Q	E
ANT								
2. Number of Poles								
1 = SPDT 2 = DPDT 3 = 3PDT 4 = 4PDT								
3. Switch Function								
1 = ON-NONE-ON 2 = ON-NONE-(ON) 3 = ON-OFF-ON 4 = (ON)-OFF-(ON) 5 = ON-OFF-(ON) 6 = ON-ON-ON **See 3-way wiring section for details								
4. Actuator								
T = 5.08mm, standard S = 10.67mm, standard X = 13.97mm, standard V = 16.26mm, standard W = 21.34mm, standard Y = 6.35mm, flat toggle *only available with AR1, AR2, AN1, AN2 bushing F = 11.43mm, flat toggle *only available with AR1, AR2, AN1, AN2 bushing G = 21.33mm, flat toggle *only available with AR1, AR2, AN1, AN2 bushing K = 13.49mm, flat toggle *only available with AR1, AR2, AN1, AN2 bushing Z = 12.37mm, large toggle *only available with BZ, BZR bushing Z1 = 17.45mm, large toggle *only available with BZ, BZR bushing LK = 16.10mm / 17.88mm, locking toggle, round top *only available with K, K1 bushing LK1 = 16.81mm / 18.59mm, locking toggle, flat top *only available with K, K1 bushing								
5. Bushing								
E / E1 = 8.89mm, ¼-40NS / non-threaded, keyway F / F1 = 7.11mm, ¼-40NS / non-threaded, keyway J = 8.89mm, ¼-40NS, flat W = 8.90mm, M6P-0.75 (metric) keyway H = 8.00mm, high torque, ¼-40NS, keyway G = 7.52mm, high torque, ¼-40NS, flat AR1 / AR2 = 7.55mm, anti-rotation, ¼-40NS / non-threaded, keyway AN1 / AN2 = 7.55mm, anti-rotation, ¼-40NS / non-threaded, flat BZ = 11.38mm, 15/32-32NS, keyway BZR = 11.38mm, 15/32-32NS, keyway with support insert L = 7.47mm, ¼-40NS, keyway, splash proof K / K1 = 8.00mm, ¼-40NS, non-threaded, keyway ** See actuator option section for bushing availability, with various actuators								
6. Terminals								
B = Solder Lug C = PC Pin D = Quick Connect H = Horizontal Mount, right angle PC pin, <i>HS = Snap-In</i> V = Vertical Mount, right angle PC pin, <i>VS = Snap-In</i> W = Wire Wrap** S20 or S25 = PC pin with support bracket, <i>V20 or V25 = Snap-In support bracket</i> S35 or S40 = PC pin with support bracket, <i>V35 or V40 = Snap-In support bracket</i>				** Wire wrap terminals available in various lengths, contact factory				
7. Contacts								
Q = Silver plated R = Gold plated G = Gold over Silver plated								
8. Epoxy Seal								
E = Epoxy Seal								
9. Actuator Cover								
Blank = No cover S = for S, T, X, V & W actuators E = for E, F, J, & G bushings Z = for BZ & BZR bushings		Actuator Cover Colors		1 = White 2 = Black 3 = Red ** Color choices only available with S toggle cover				

## Switch Function

### SPDT

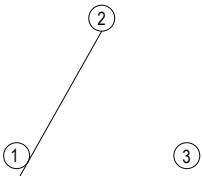
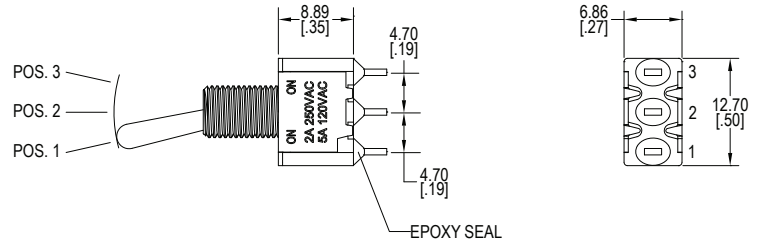
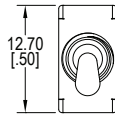

Function	Toggle Position		
1	ON	NONE	ON
2	ON	NONE	(ON)
3	ON	OFF	ON
4	(ON)	OFF	(ON)
5	ON	OFF	(ON)
Terminals	2-3	-	2-1

### DPDT

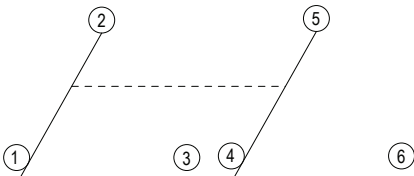
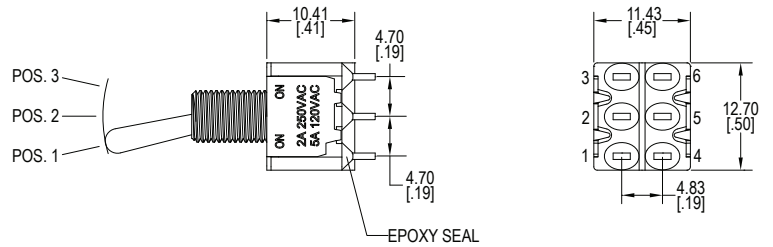
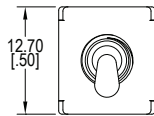

Function	Toggle Position		
1	ON	NONE	ON
2	ON	NONE	(ON)
3	ON	OFF	ON
4	(ON)	OFF	(ON)
5	ON	OFF	(ON)
Terminals	2-3	-	2-1
6	ON	ON	ON
Terminals	2-3 5-6	2-3 5-4	2-1 5-4

Miniature Toggle

Switch Function

3PDT

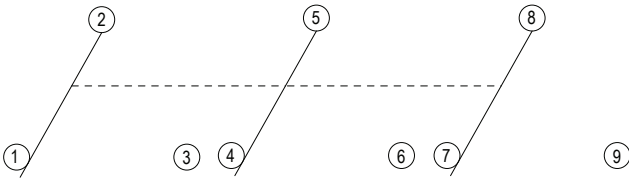
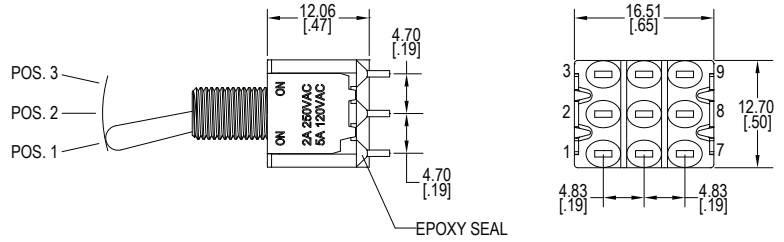
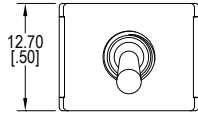

Function	Toggle Position		
1	ON	NONE	ON
2	ON	NONE	(ON)
3	ON	OFF	ON
4	(ON)	OFF	(ON)
5	ON	OFF	(ON)
Terminals	2-3 5-6 8-9	-	2-1 5-4 8-7

4PDT

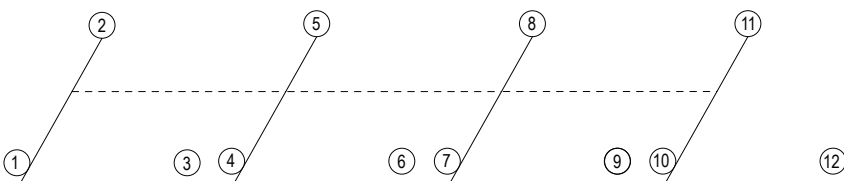
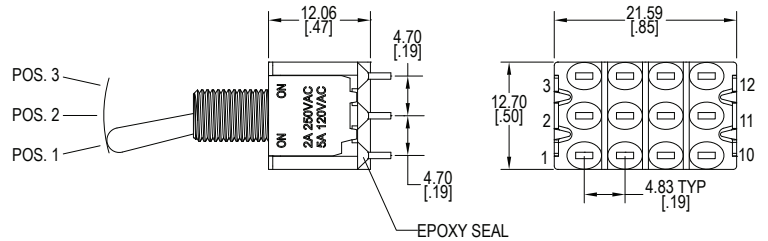
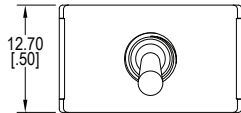
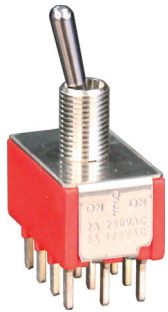

Function	Toggle Position		
1	ON	NONE	ON
2	ON	NONE	(ON)
3	ON	OFF	ON
4	(ON)	OFF	(ON)
5	ON	OFF	(ON)
Terminals	2-3 5-6 8-9 11-12	-	2-1 5-4 8-7 11-10
6	ON	ON	ON
Terminals	2-3 5-6 8-9 11-12	2-3 5-4 8-9 11-10	2-1 5-4 8-7 11-10

## Actuator Options

Actuator lengths shown with E bushing, subtract 1.78mm for F/F1 bushing, subtract 0.51mm for M bushing

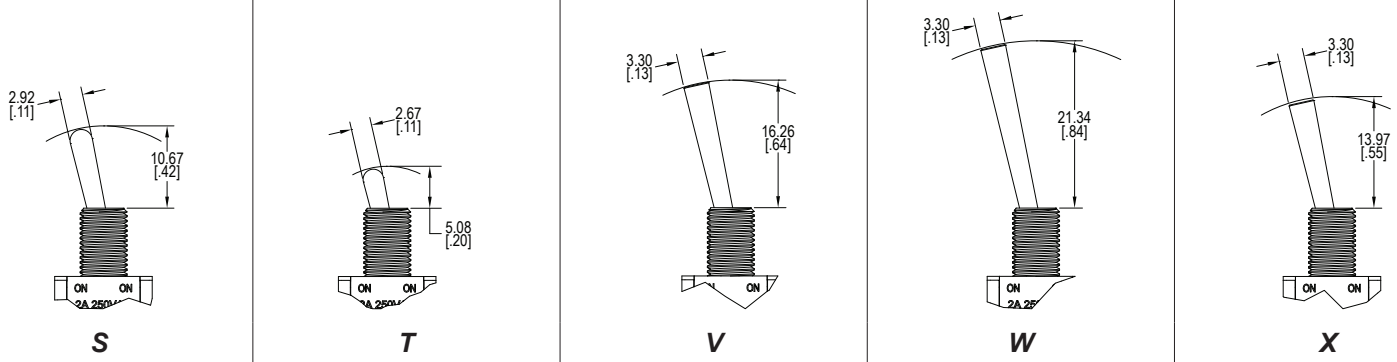

Below Actuators only available with AR1, AR2 & AN1/AN2 bushing

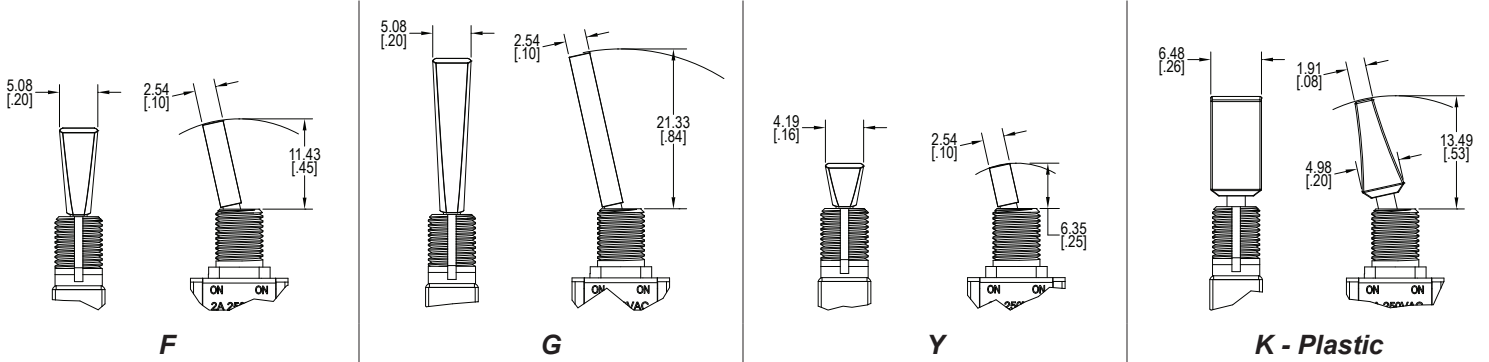

Below Actuators only available with BZ & BZR bushing

Below Actuators only available with K & K1 Bushing. LK & LK1 are not available with momentary functions.

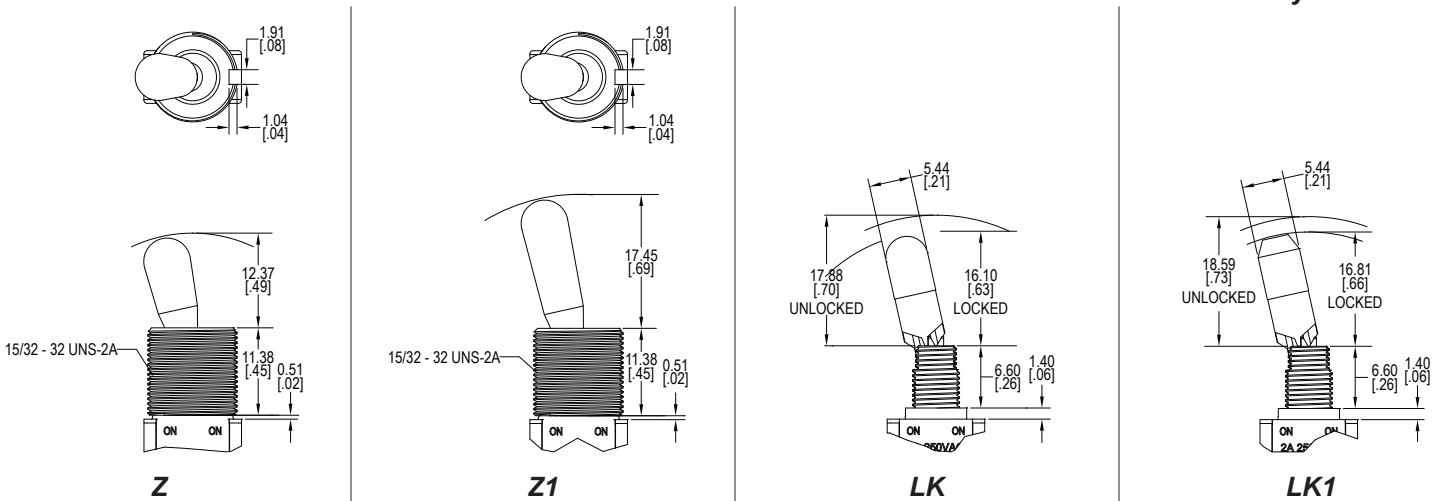

### Bushing Options

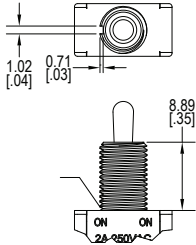

**E - Threaded**  
**E1 - Non-Treated**

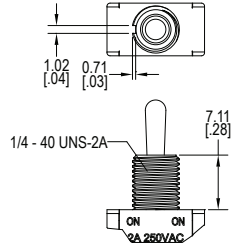

**F - Threaded**  
**F1 - Non-Treated**

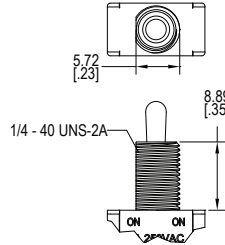

**J - Threaded**

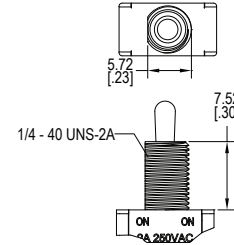

**G - Threaded**  
**High Torque**

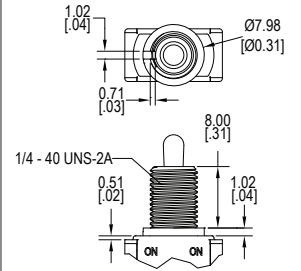

**H - Threaded**  
**High Torque**

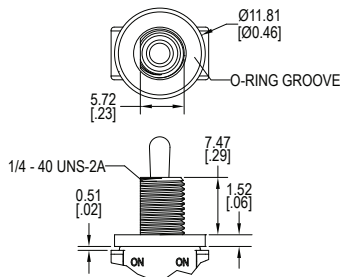

**L - Threaded**  
**Splash Proof**

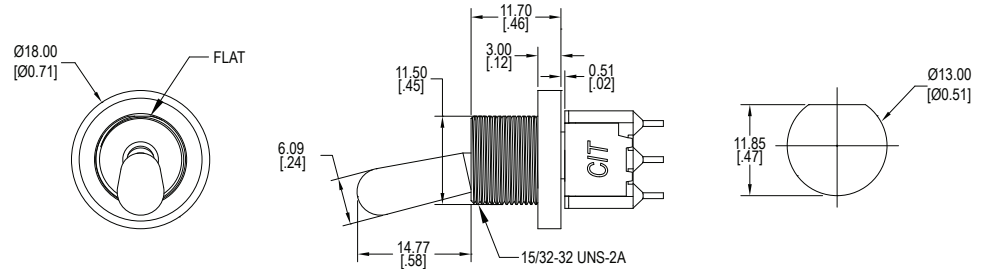

**LZ - Threaded**

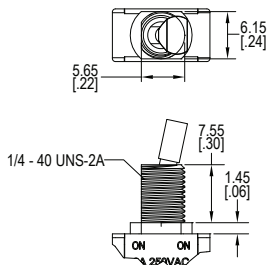

**AN1 - Threaded**  
**Anti-Rotation**

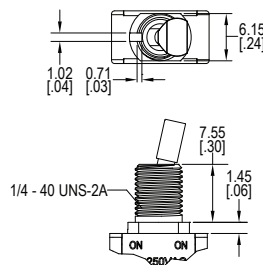

**AR1 - Threaded**  
**Anti-Rotation**

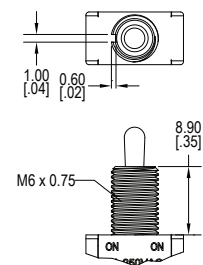

**W - Threaded**  
**Metric**

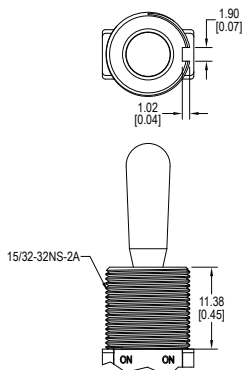

**BZ - Keypaw**

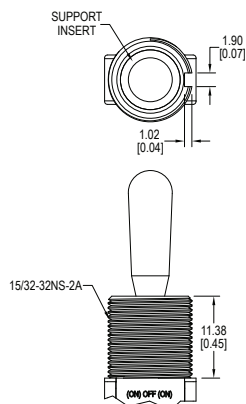

**BZR - Keypaw with Support Insert**

## Panel Cutouts

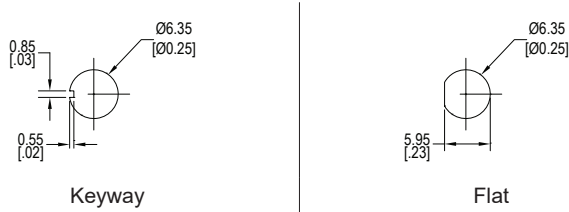

**1/4 Inch Bushing  
without Locking Ring**

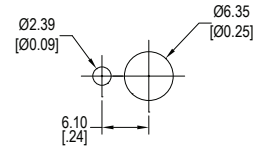

**1/4 Inch Bushing  
with Standard Locking Ring**

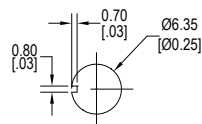

**Metric Bushing  
without Locking Ring**

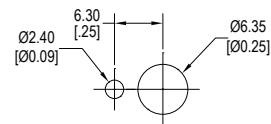

**Metric Bushing  
with Locking Ring**

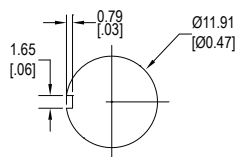

**15/32 Inch Bushing  
without Locking Ring**

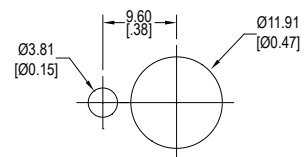

**15/32 Inch Bushing  
with Standard Locking Ring**

## Terminal Options

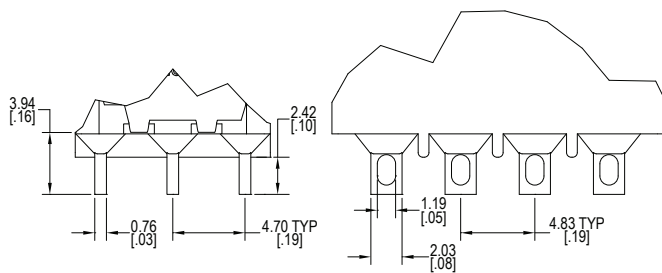

**B - Solder Lug**

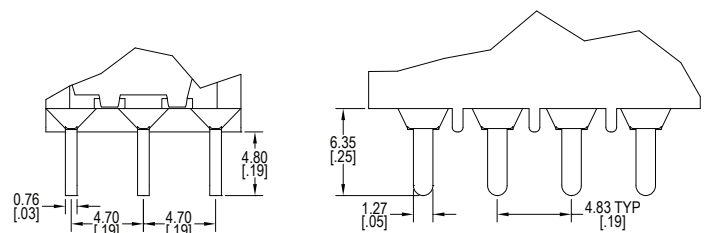

**C - PC Pin**

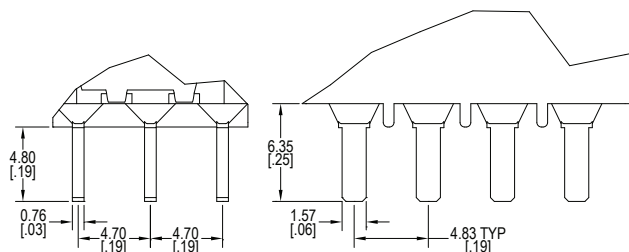

**D - Quick Connect**

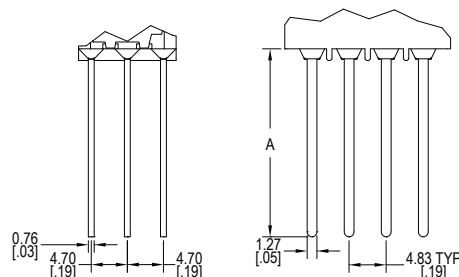

**W - Wire Wrap**

Terminal Length	
Option Code	"A" Dimension
W1	18.70
W2	24.20
W3	10.55
W4	26.97

## Terminal Options

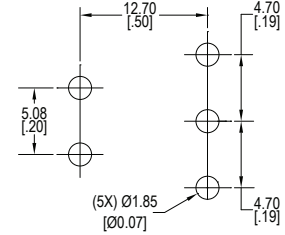
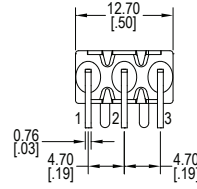
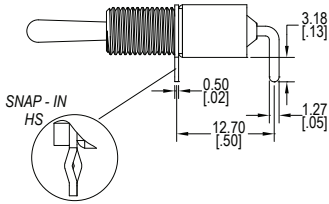
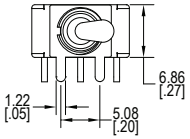

**H (HS - Snap-in) = Horizontal mount, right angle PC pins, single pole**

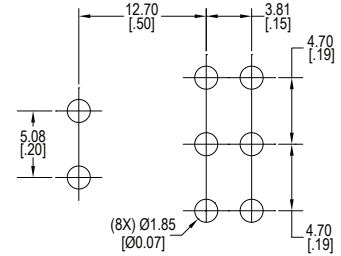
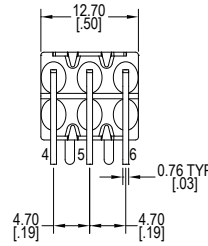
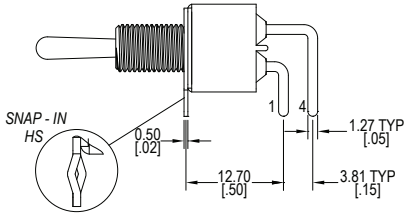
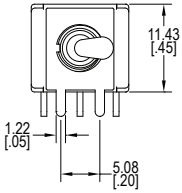

**H (HS - Snap-in) = Horizontal mount, right angle PC pins, double pole**

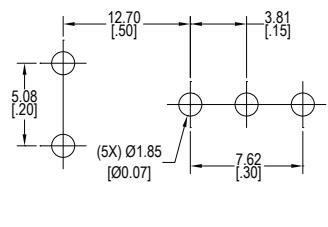
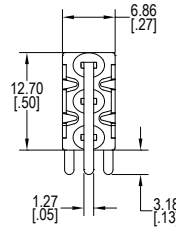
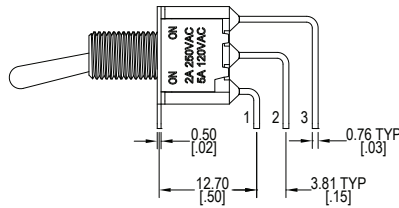
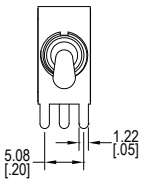

**V (VS - Snap-in) = Vertical mount, right angle PC pins, single pole**

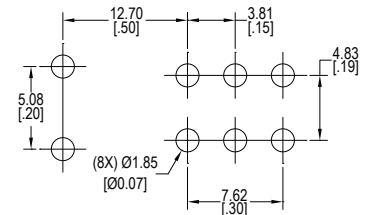
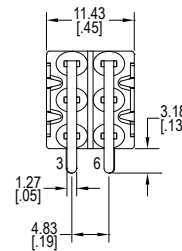
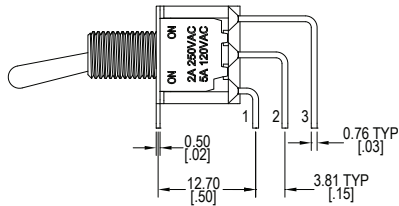
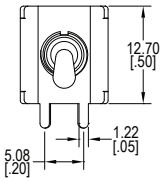

**V (VS - Snap-in) = Vertical mount, right angle PC pins, double pole**



## Terminal Options

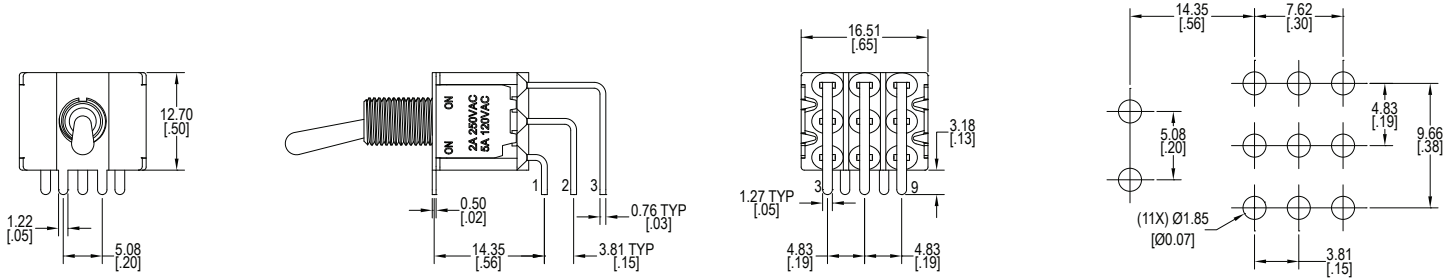

**V (VS - Snap-in) = Vertical mount, right angle PC pins, three pole**

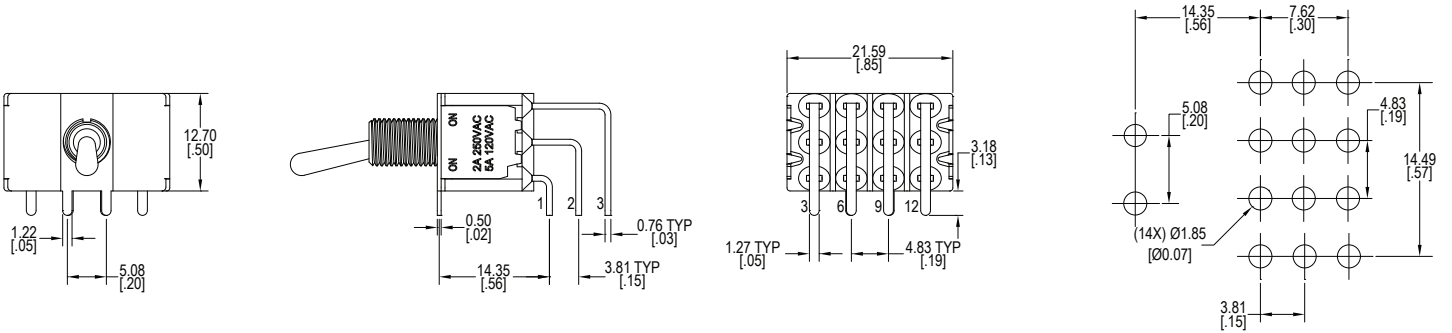

**V (VS - Snap-in) = Vertical mount, right angle PC pins, four pole**

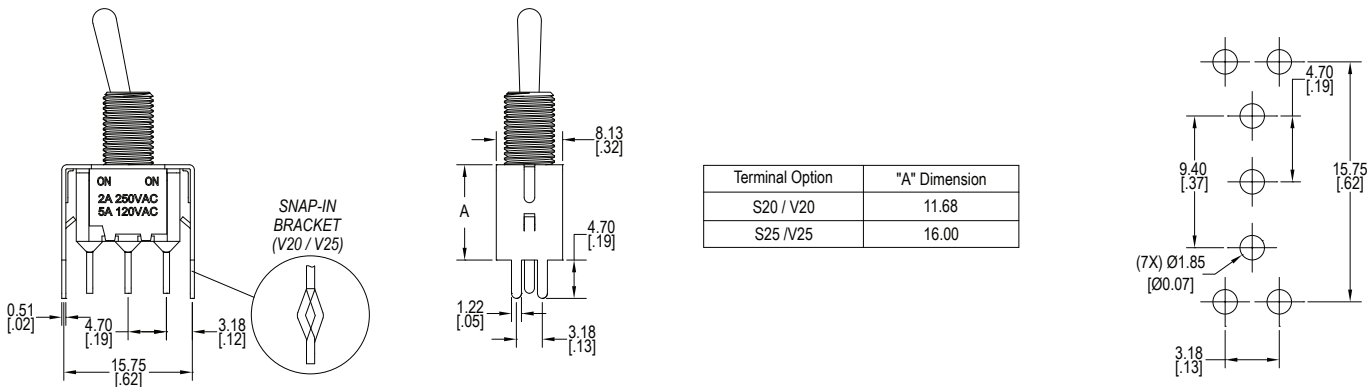

**S20/S25 (V20/V25 - Snap-in) = PC pins with support bracket, single pole**

## Terminal Options

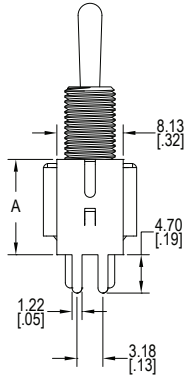
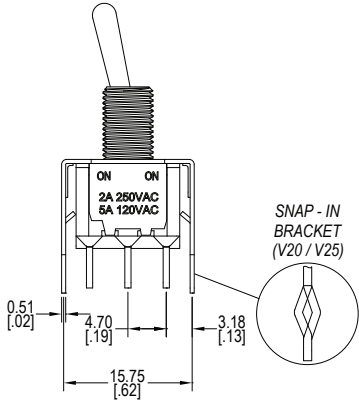

Terminal Option	"A" Dimension
S20 / V20	11.68
S20 / V25	16.00

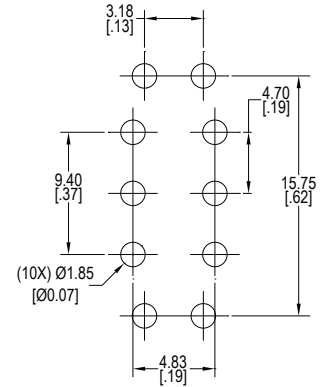

**S20/S25 (V20/V25 - Snap-in) = PC pins with support bracket, double pole**

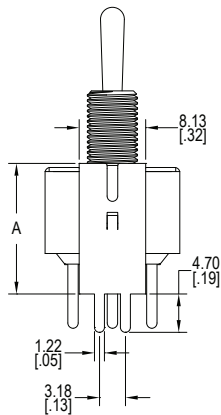
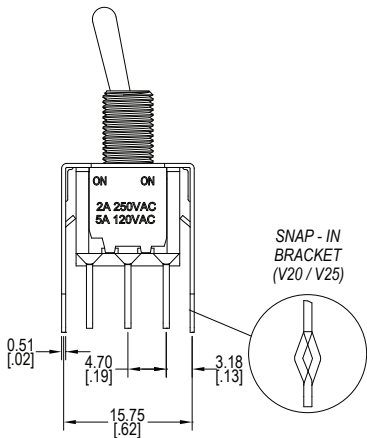

Terminal Option	"A" Dimension
S25 / V25	16.00

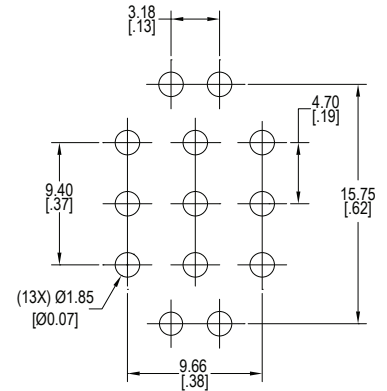

**S20/S25 (V20/V25 - Snap-in) = PC pins with support bracket, three pole**

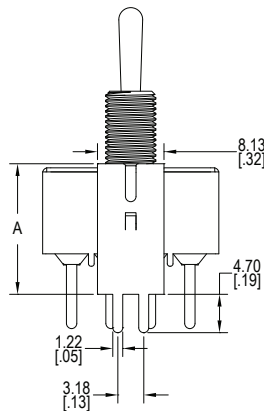
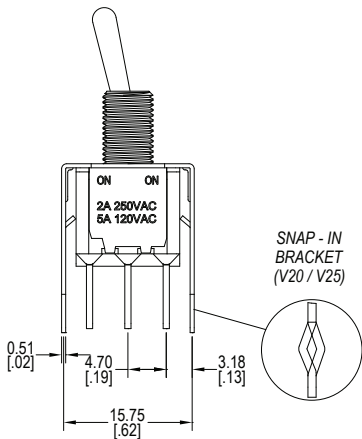

Terminal Options	"A" Dimension
S25 / V25	16.00

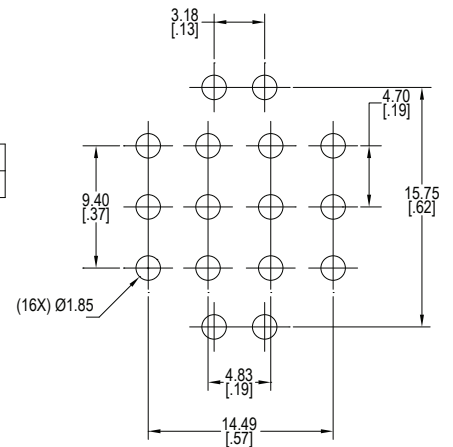

**S20/S25 (V20/V25 - Snap-in) = PC pins with support bracket, four pole**

## Terminal Options

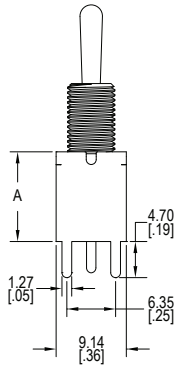
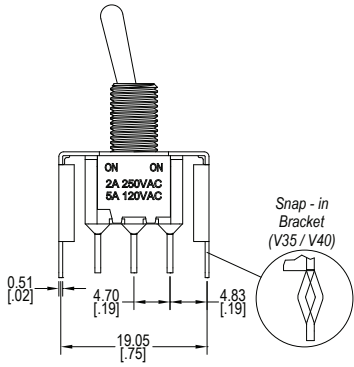

Terminal Option	"A" Dimension
S35 / V35	11.68
S40 / V40	16.00

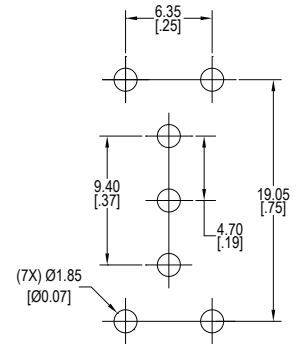

**S35 (V35 - Snap-in) = PC pins with support bracket, single pole**

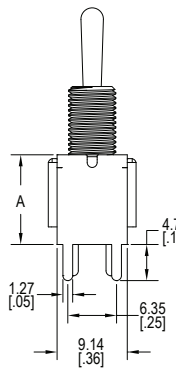
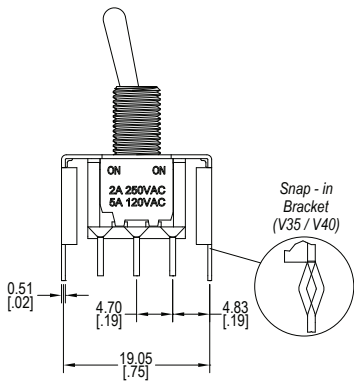

Terminal Option	"A" Dimension
S35 / V35	11.68
S40 / V40	16.00

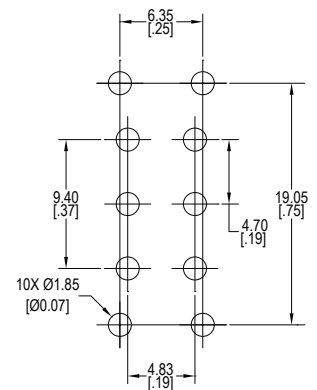

**S35 (V35 - Snap-in) = PC pins with support bracket, double pole**

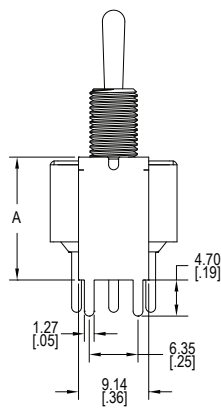
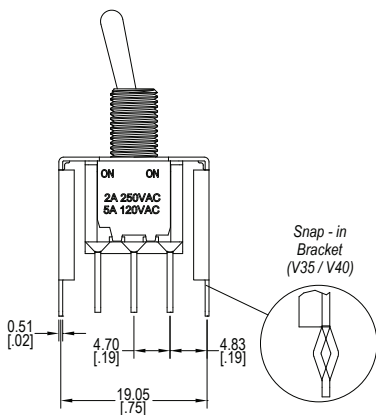

Terminal Option	"A" Dimension
S40 / V40	16.00

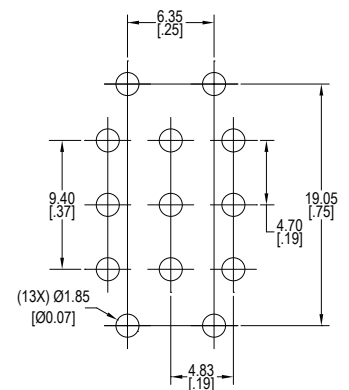

**S40 (V40 - Snap-in) = PC pins with support bracket, three pole**

## Terminal Options

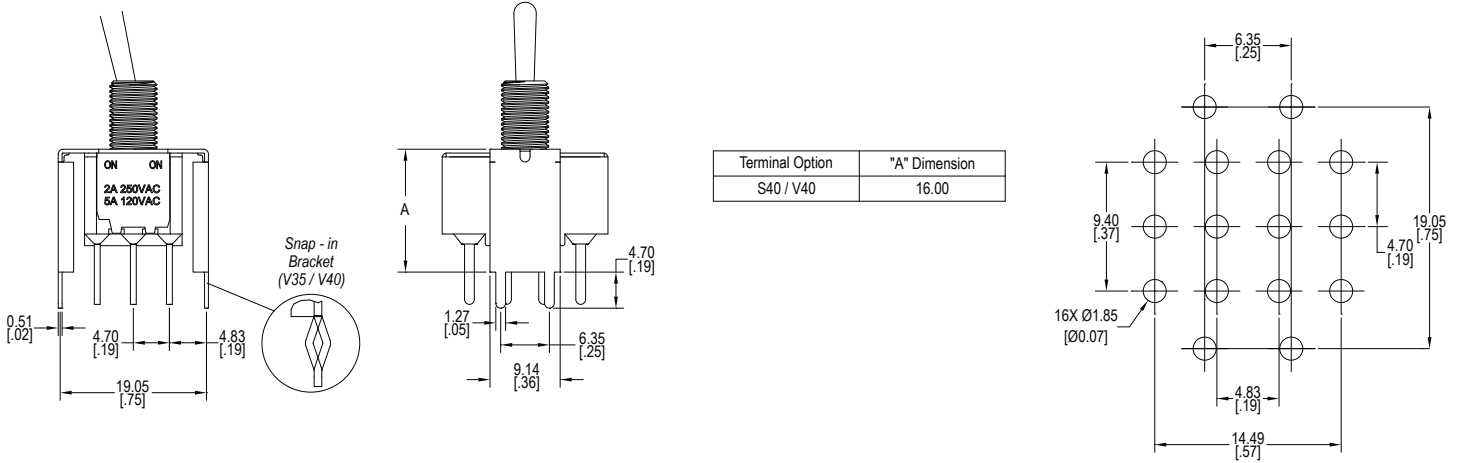

S40 (V40 - Snap-in) = PC pins with support bracket, four pole

## Contact Options

Designator	Contact Material	Terminal Material	Electrical Ratings
Q	Silver Plating	Silver Plating	5A @ 120VAC, 28VDC; 2A @ 250VAC
R	Gold over Nickel Plating	Gold over Nickel Plating	0.4VA max @ 20VAC or VDC max
G	Gold over Silver Plating	Gold over Silver Plating	0.4VA max @ 20VAC or VDC max or 5A @ 120VAC, 28VDC; 2A @ 250VAC

## Three Way Wiring Diagram

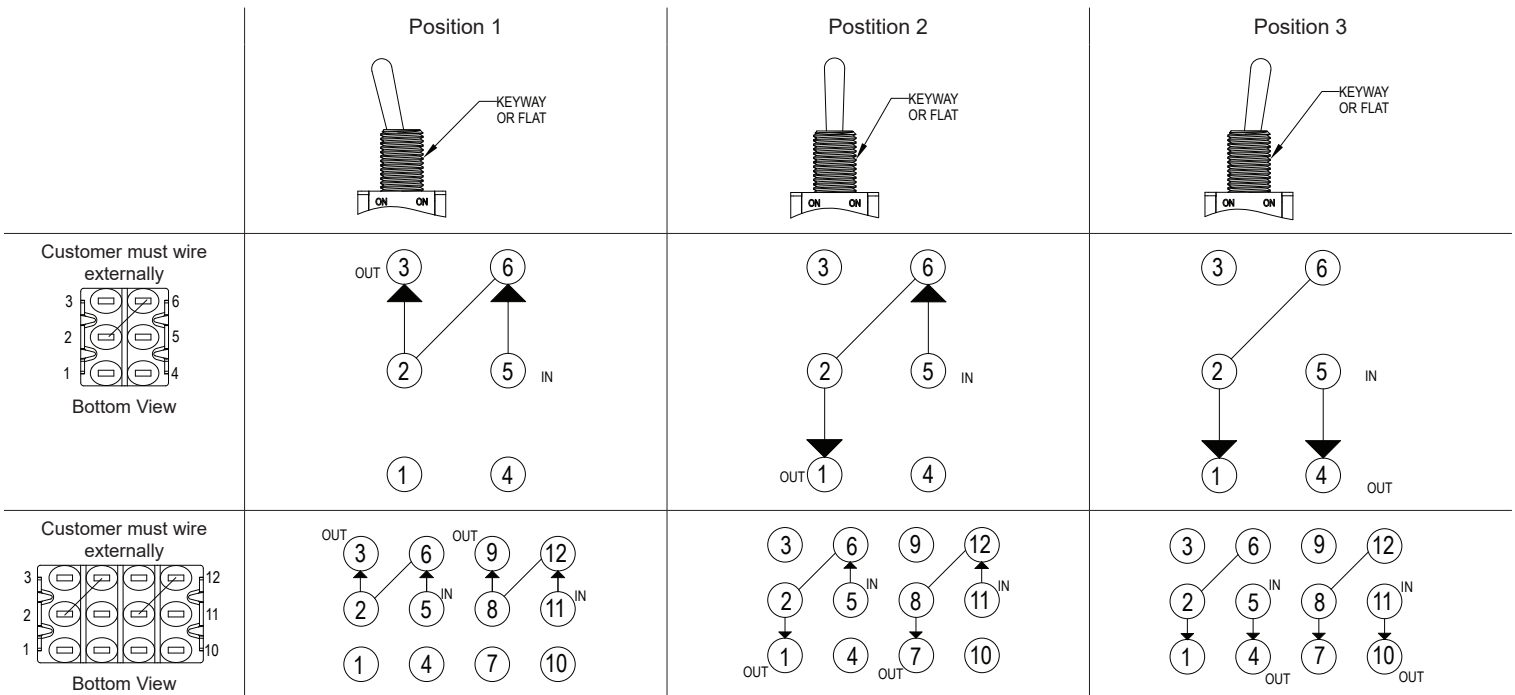

## Cap Options

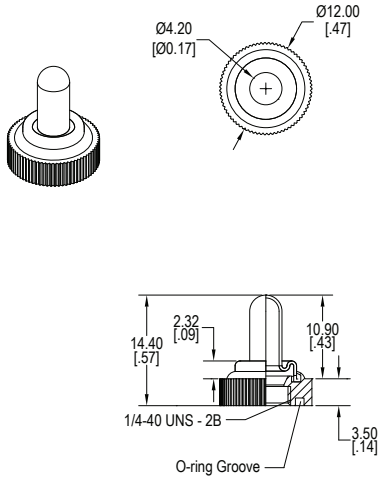

**Sealed Boot E  
 Knurled Nut**

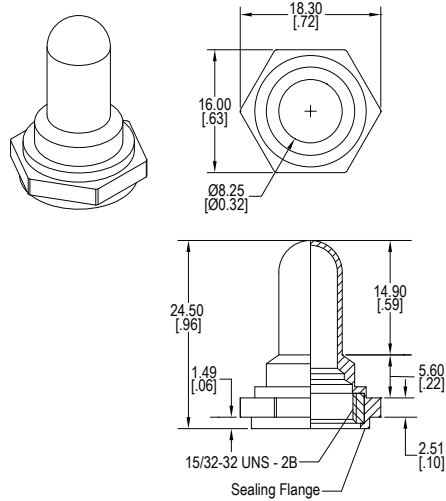

**Sealed Boot Z3  
 Rubber Coated**

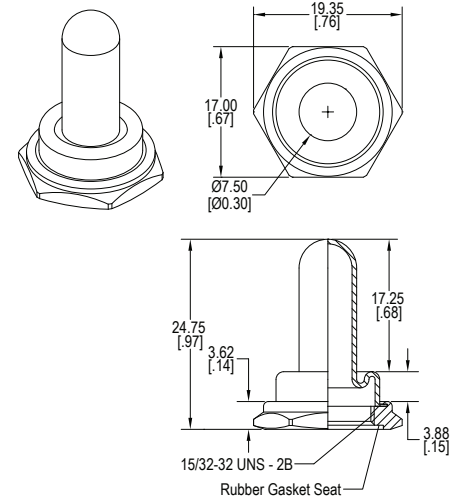

**Sealed Boot Z4  
 Plain Hex Nut**

## Hardware

### 15/32 - 32 Hardware

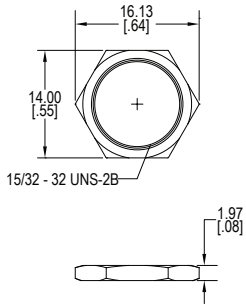

**Hex Nut**

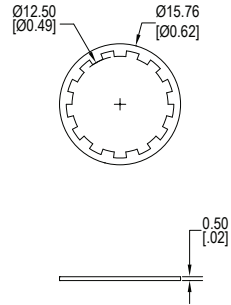

**Lock Washer**

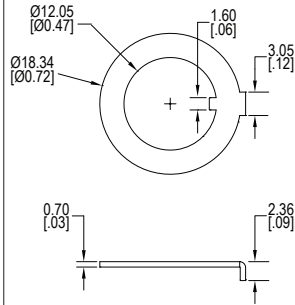

**Locking Ring-Keyway**

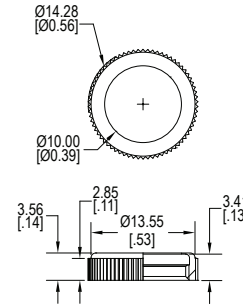

**Knurled Nut**

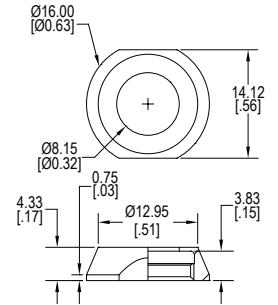

**Dress Nut**

## Hardware

### 1/4 - 40 Hardware

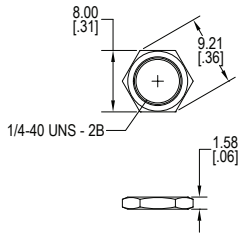

**Hex Nut**

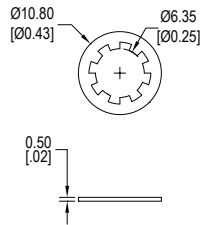

**Lock Washer**

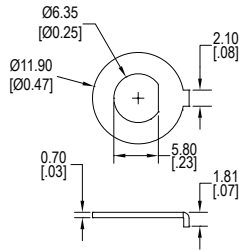

**Locking Ring-Flat**

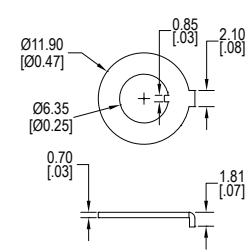

**Locking Ring-Keyway**

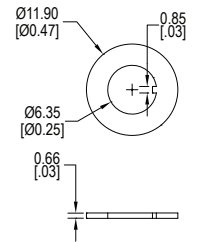

**Washer-Keyway**

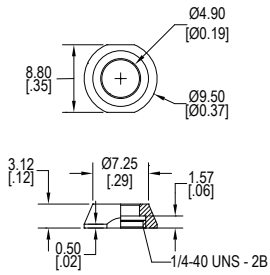

**Dress Nut A**

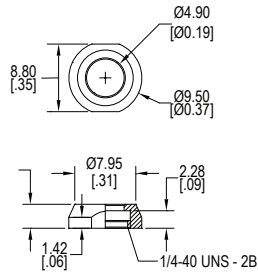

**Dress Nut B**

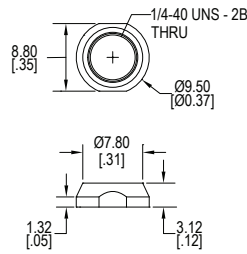

**Dress Nut C**

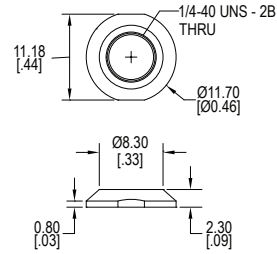

**Dress Nut D**

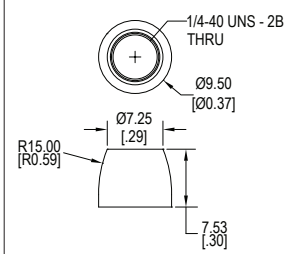

**Dress Nut E**

### Collars

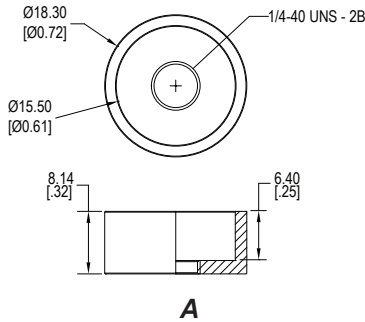

**A**

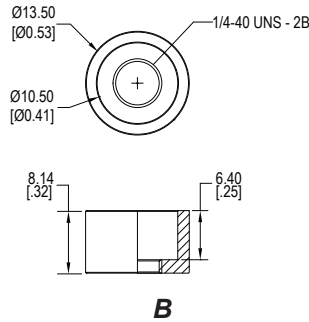

**B**

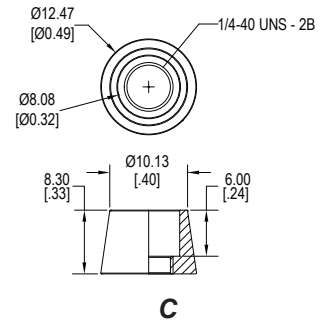

**C**

### Knurled Nuts

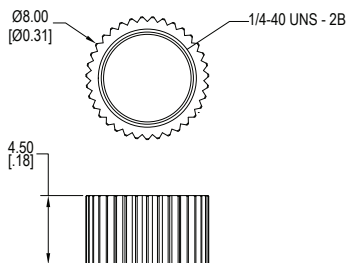
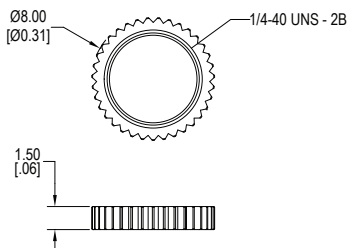

### Toggle Cap "S"

